



## Descriptions

- General purpose amplifier
- High voltage application

## Features

- High collector breakdown voltage  
:  $V_{CEO} = 120V$
- Low collector saturation voltage  
:  $V_{CE(sat)} = 0.5V(MAX.)$
- “Green” device and RoHS compliant device
- Available in full lead (Pb)-free device

## PIN Connection

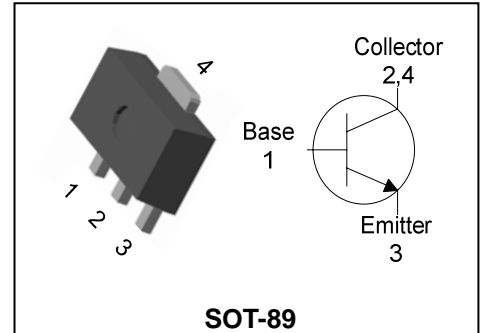

## Ordering Information

Type No.	Marking	Package Code
STC4073F	M73 □YWW	SOT-89

M73: DEVICE CODE, □ :  $h_{FE}$  rank, YWW(Y : Year code, WW : Weekly code)

## Absolute maximum ratings

( $T_a = 25^\circ C$ )

Characteristic	Symbol	Ratings	Unit
Collector-Base voltage	$V_{CBO}$	120	V
Collector-Emitter voltage	$V_{CEO}$	120	V
Emitter-Base voltage	$V_{EBO}$	6	V
Collector current	$I_C$	1	A(DC)
	$I_{CP}^*$	2	A(Pulse)
Collector power dissipation	$P_C$	0.5	W
	$P_C^{**}$	1	
Junction temperature	$T_J$	150	$^\circ C$
Storage temperature	$T_{stg}$	-55 ~ 150	$^\circ C$

Characteristic		Symbol	Typ.	Max	Unit
Thermal resistance	Junction-ambient	$R_{th(J-A)}$	-	250.0	$^\circ C/W$
		$R_{th(J-A)}^{**}$	-	125.0	

\* : Single pulse,  $t_p = 300 \mu s$

\*\* : When mounted on ceramic substrate( $250 \text{ mm}^2 \times 0.8 \text{ t}$ )

## Electrical Characteristics

(Ta=25°C)

Characteristic	Symbol	Test Condition	Min.	Typ.	Max.	Unit
Collector-Base breakdown voltage	$BV_{CBO}$	$I_C=100\mu A, I_E=0$	120	-	-	V
Collector-Emitter breakdown voltage	$BV_{CEO}$	$I_C=1mA, I_B=0$	120	-	-	V
Emitter-Base breakdown voltage	$BV_{EBO}$	$I_E=100\mu A, I_C=0$	6	-	-	V
Collector cut-off current	$I_{CBO}$	$V_{CB}=120V, I_E=0$	-	-	0.1	$\mu A$
Emitter cut-off current	$I_{EBO}$	$V_{EB}=4V, I_C=0$	-	-	0.1	$\mu A$
DC current gain	$h_{FE}^{1)}$	$V_{CE}=5V, I_C=30mA$	200	-	400	-
Collector-Emitter saturation voltage	$V_{CE(sat)}^{2)}$	$I_C=500mA, I_B=50mA$	-	-	0.5	V
		$I_C=100mA, I_B=10mA$	-	-	0.1	V
		$I_C=120mA, I_B=2mA$	-	-	0.15	V
		$I_C=200mA, I_B=2mA$	-	-	0.3	V
Base-Emitter turn on voltage	$V_{BE(on)}^{2)}$	$V_{CE}=0.2V, I_C=200mA$	0.6	-	0.85	V
Base-Emitter saturation voltage	$V_{BE(sat)}^{2)}$	$I_C=500mA, I_B=50mA$	-	-	1.2	V
Transition frequency	$f_T$	$V_{CE}=5V, I_C=50mA$	-	170	-	MHz
Collector output capacitance	$C_{ob}$	$V_{CB}=10V, I_E=0, f=1MHz$	-	10	-	pF

\* Note 1) hFE Rank : 200~400 only

\* Note 2) Pulse Tester : Pulse Width  $\leq 300\mu s$ , Duty Cycle  $\leq 2.0\%$

Electrical Characteristic Curves

Fig. 1  $P_C - T_a$

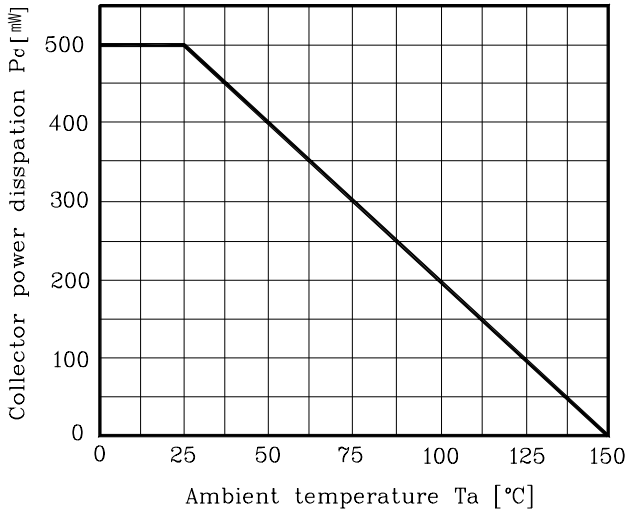

Fig. 2  $I_C - V_{BE}$

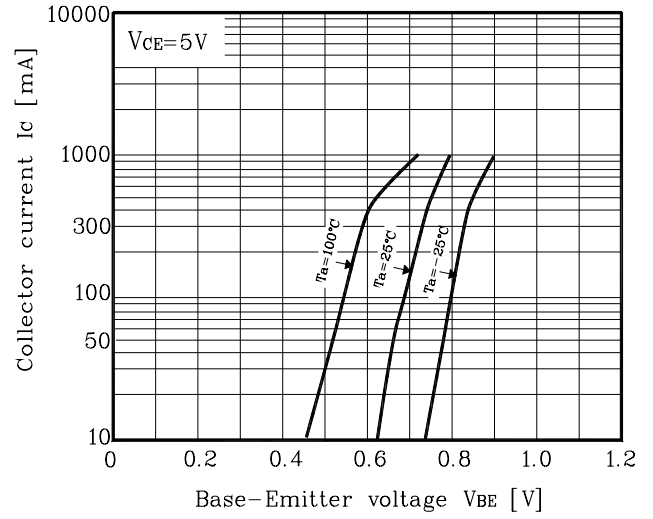

Fig. 3  $V_{CE(sat)} - I_C$

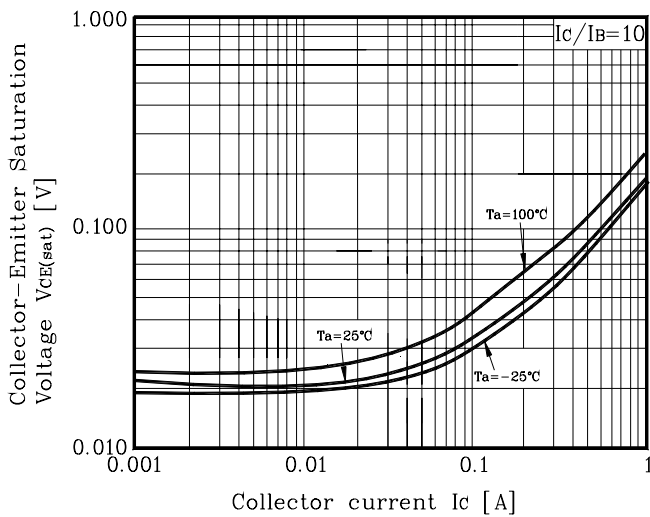

Fig. 4  $I_C - V_{CE}$

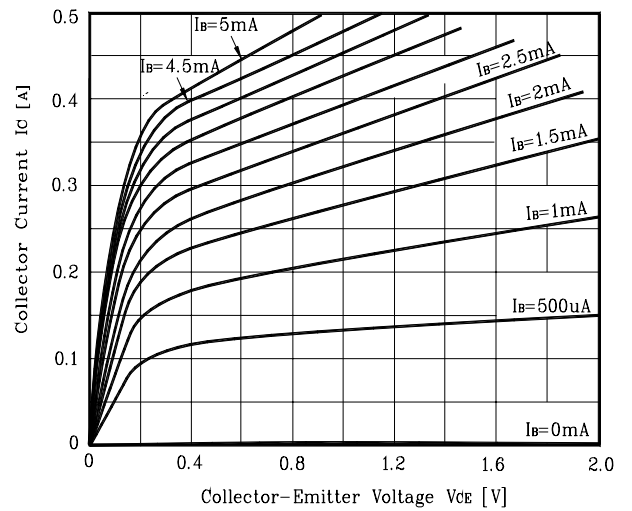

Fig. 5  $I_C - V_{CE}$

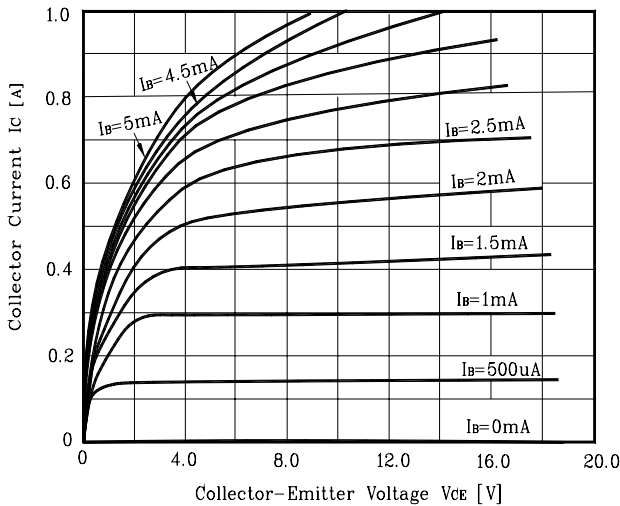
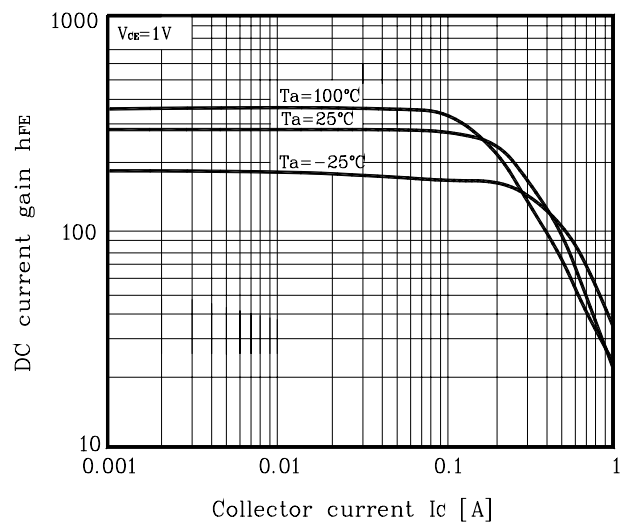
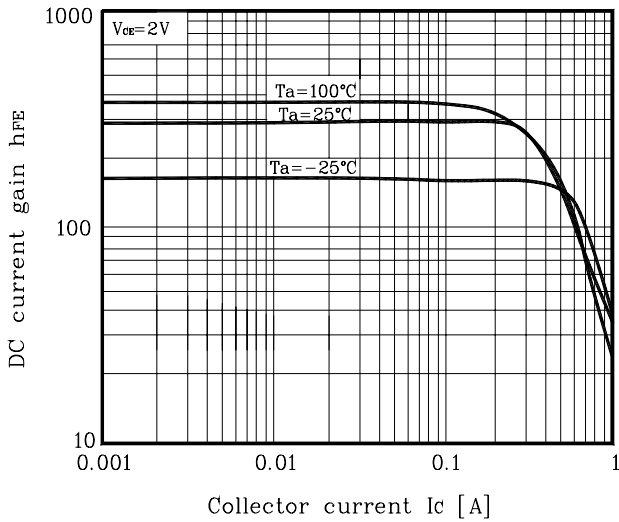

Fig. 6  $h_{FE} - I_C$



## Electrical Characteristic Curves

**Fig. 7  $h_{FE}-I_C$**



**Fig. 8  $h_{FE}-I_C$**

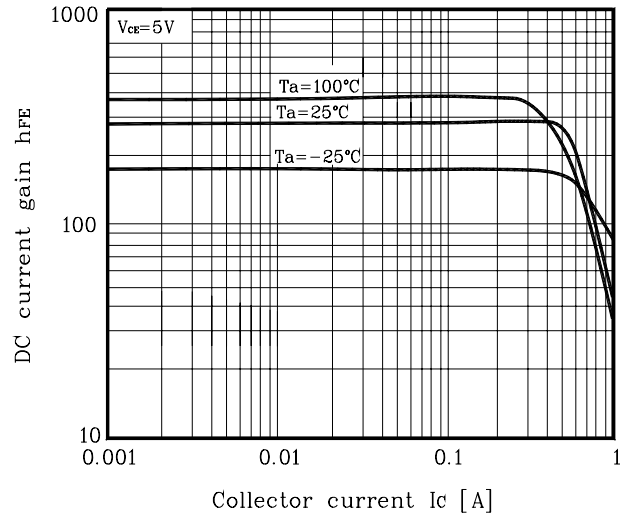

**Fig. 9  $h_{FE}-I_C$**

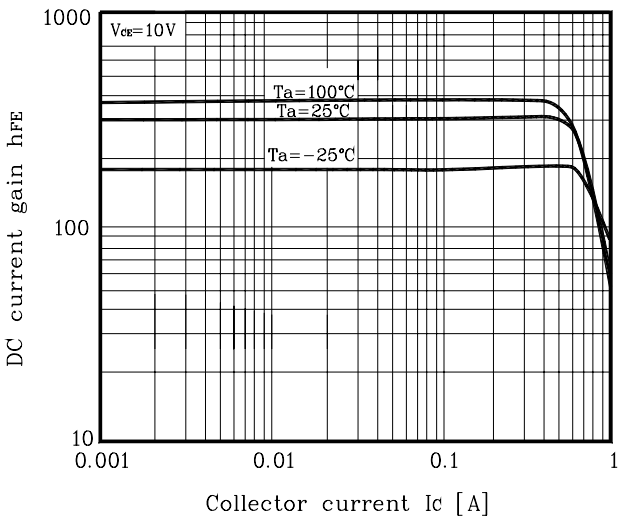

**Fig. 10  $C_{ob}-V_{CB}$**

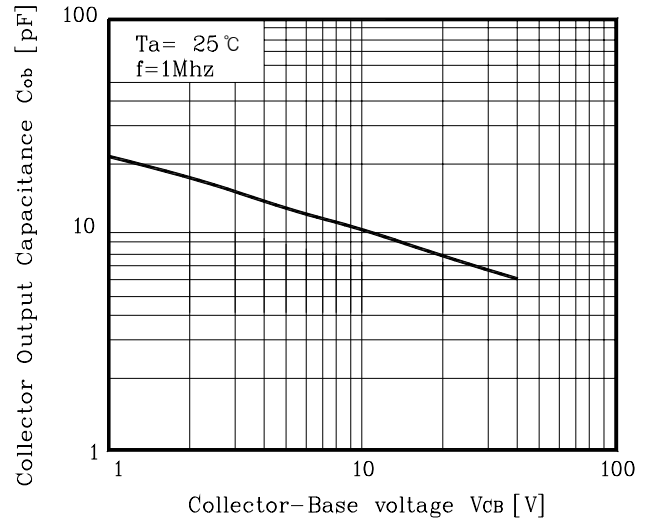

**Fig. 11  $f_T - I_C$**

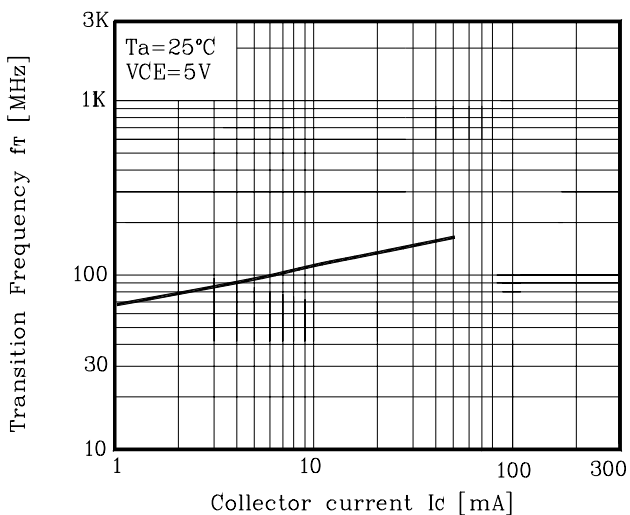

**Fig. 12 Safe operating Area**

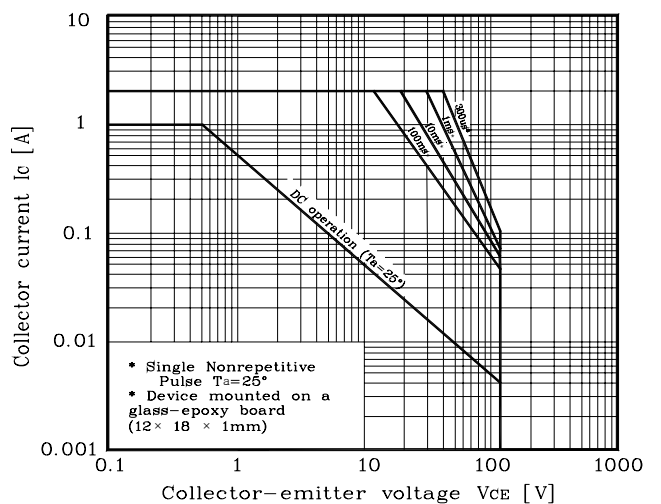

Outline Dimension(mm)

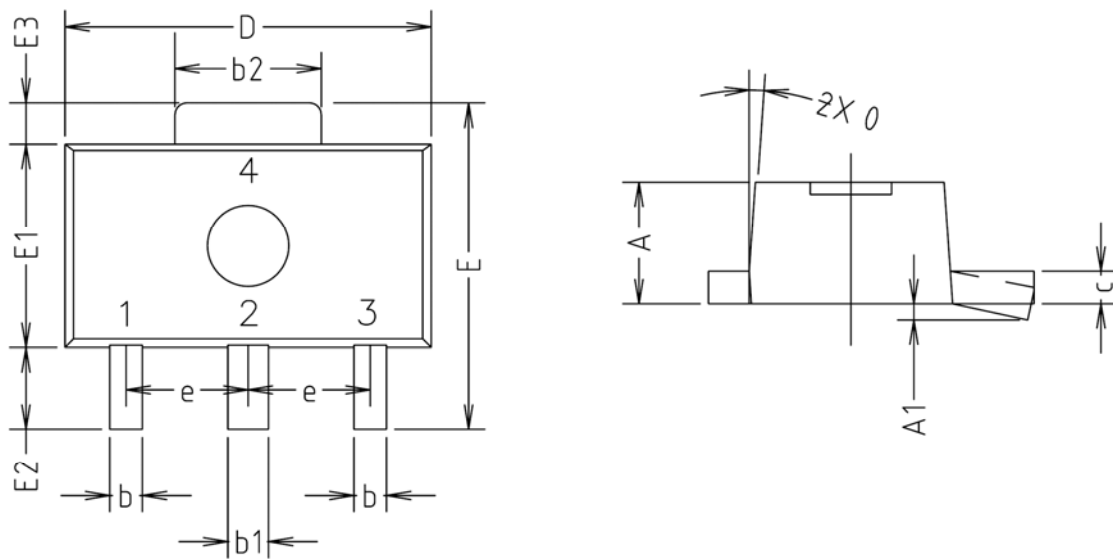

SYMBOL	MILLIMETERS			NOTE
	MINIMUM	NOMINAL	MAXIMUM	
A	1.40	1.50	1.60	
A1	0.00	—	0.10	
b	0.38	0.42	0.48	
b1	0.48	0.52	0.58	
b2	1.79	1.82	1.87	
c	0.40	0.42	0.46	
D	4.40	4.50	4.70	
E	3.70	4.00	4.30	
E1	2.40	2.50	2.70	
E2	0.80	1.00	1.20	
E3	0.40	0.50	0.60	
e	1.50 TYP.			
θ	4° TYP.			

※Recommend PCB solder land [Unit: mm]

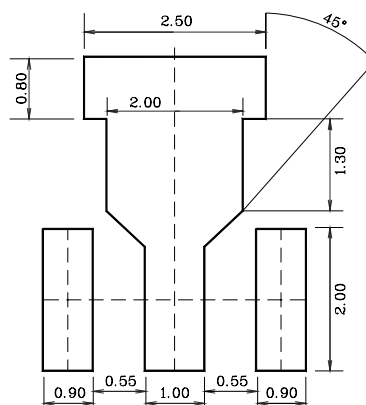

**The AUK Corp. products are intended for the use as components in general electronic equipment (Office and communication equipment, measuring equipment, home appliance, etc.).**

**Please make sure that you consult with us before you use these AUK Corp. products in equipments which require high quality and / or reliability, and in equipments which could have major impact to the welfare of human life(atomic energy control, airplane, spaceship, transportation, combustion control, all types of safety device, etc.). AUK Corp. cannot accept liability to any damage which may occur in case these AUK Corp. products were used in the mentioned equipments without prior consultation with AUK Corp..**

**Specifications mentioned in this publication are subject to change without notice.**